

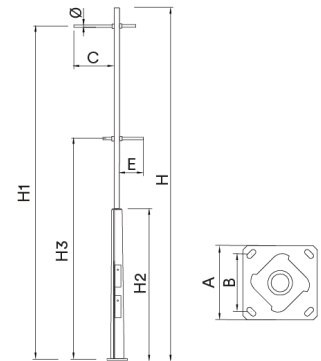

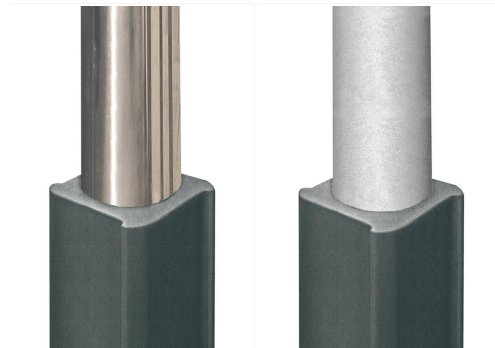



Telescopic Pole with a square-section base and rounded corners, made of galvanized steel S-235 JR with a standard micro-textured black finish. Cylindrical shaft with Integrated side panel made of hot-dip galvanized steel, with single and double options at the same and different heights.

Total Pole height: 5 to 11 meters, with termination in Lateral Ø60 mm. Design with a distinctive aesthetic and unique presence, ideal for promenades and avenues, offering a Light Point that adds personality to the municipality.

Optional:

- Shaft and in polished stainless steel.
- Anti-urine treatment at the base.



| Ref. | H | H1 | H2 | H3 | Ø | C | D | A | B |  |  |  |  |  |
|---------|-------|-------|------|------|----|------|-----|-----|-----|---|---|---|---|---|
| ICNT50 | 5000 | 4500 | 1210 | 4500 | 60 | 650 | - | 300 | 200 | M18x500 | x | x | - | - |
| ICNT70 | 7000 | 6500 | 2500 | 4500 | 60 | 1050 | 600 | 400 | 300 | M18x500 | x | x | x | - |
| | 7000 | - | - | - | - | - | - | - | - | M18x500 | - | - | - | x |
| ICNT90 | 9000 | 8500 | 2500 | 4500 | 60 | 1050 | 600 | 400 | 300 | M18x500 | x | x | x | - |
| | 9000 | - | - | - | - | - | - | - | - | M18x500 | - | - | - | x |
| ICNT110 | 11000 | 10500 | 2500 | 4500 | 60 | 1050 | 600 | 400 | 300 | M22x700 | x | x | x | - |
| | 11000 | - | - | - | - | - | - | - | - | M22x700 | - | - | - | x |



ALFUM



ILDH



ILDH